

THE ALLPOWER SOURCE

EMI SUPPRESSION DEVICES

FULL RANGE OF FERRITE BEADS
LARGE ASSORTMENT OF FERRITE CLAMPS



- ATTENUATION OF CONDUCTED NOISE
- COMMON MODE BALUNS
- D-SUBCONNECTOR NOISE SUPPRESSORS
- FLAT CABLE CLAMPS
- FERRITE BEADS

ALLPOWER DIVISION

TECHNOLOGY DYNAMICS INC.

100 School Street, Bergenfield, NJ 07621 Phone: (201) 385-0500, Fax: (201) 385-0702

www.theallpower.com

1. Applications and Characteristics:

If the design frequency is below 300KHz, the preferred choice of RF circuits for the iron powder core are: DC power supply chokes, motors, dimmer control filteres and other EMI/RFI circuits.



2. Temperature Effects:

The iron powder core is well suited from -55°C to +125°C. Because the iron powder core does not have a low curie temperature it will function to several hundred degrees Celcius. However, continued operation above 200°C may result in a permanent shift in characteristic.

EPOXY COATING: 94V-0
 COLOR CODE: YELLOW/WHITE

5. Iron Powder Material Properties

PROPERTY	UNIT	SYBOL	26
Initial Permeability		μ_i	75
Curie Temperature	°C	Tc	≥300
Pratical Frequency Range	KHZ		1-300
Specific Gravity		d	6.7
Temperature Stability (+)	Ppm/°C		780

5. Dimensions and Magnetic Parameters

Symbols	Definitions
L_e	Effective path length
A_e	Effective cross-sectional area
V_e	Effective core volume
A_L	Inductance factor

ITEM	Mechanical Dimension			Magnetic Dimension			AL (nH/N ²)		
	OD (mm)	ID (mm)	HT (mm)	L_e cm ²	A_e cm ²	V_e cm ²	M25 + 25%	M50 + 25%	M70 + 30%
T4x2x2	4.0 ± 0.2	2.0 ± 0.2	2.0 ± 0.2	0.9430	0.0200	0.1885	666	1333	1866
T6x3x2	6.0 ± 0.3	3.0 ± 0.2	2.0 ± 0.2	1.4130	0.0300	0.0423	666	1333	1866
T6x3x3	6.0 ± 0.3	3.0 ± 0.2	3.0 ± 0.3	1.4130	0.0450	0.0636	1000	2000	2800
T9x5x3	9.0 ± 0.3	5.0 ± 0.3	3.0 ± 0.3	2.1991	0.0600	0.1319	857	1714	2400
T10.3x5.4x5	10.3 ± 0.5	5.4 ± 0.3	5.0 ± 0.3	2.4661	0.1225	0.3021	1560	3121	4369
T12x6x4	12.0 ± 0.5	6.0 ± 0.3	4.0 ± 0.3	2.8274	0.1200	0.3392	1333	2666	3733
T12.7x7.1x4	12.7 ± 0.5	7.1 ± 0.3	4.0 ± 0.3	3.1101	0.1120	0.3483	1131	2262	3167
T12.7x7.1x6.35	12.7 ± 0.5	7.1 ± 0.3	6.35 ± 0.3	3.1101	0.1778	0.5530	1796	3592	5029
T12.7x7.7x6.5	12.7 ± 0.5	7.7 ± 0.3	6.5 ± 0.3	3.2044	0.1625	0.5207	1593	3186	4461
T14x8.4x5	14.0 ± 0.5	8.4 ± 0.3	5.0 ± 0.3	3.5185	0.1400	0.4926	1250	2500	3486
T14x8.4x6	14.0 ± 0.5	8.4 ± 0.3	6.0 ± 0.3	3.5185	0.1680	0.5911	1500	3000	4200
T14x8.4x7	14.0 ± 0.5	8.4 ± 0.3	7.0 ± 0.3	3.5185	0.1960	0.6896	1750	3500	4900
T15.8x9.5x6.8	15.8 ± 0.5	9.5 ± 0.5	6.8 ± 0.3	3.9741	0.2142	0.8512	1693	3387	4741
T16x12x8	16.0 ± 0.5	12.0 ± 0.5	8.0 ± 0.3	4.3982	0.1600	0.7037	1142	2285	3200
T18x10x7	18.0 ± 0.5	10.0 ± 0.5	7.0 ± 0.3	4.3982	0.2800	1.2315	2000	4000	5600
T20x10x8	20.0 ± 0.5	10.0 ± 0.5	8.0 ± 0.5	4.7123	0.4000	1.8849	2667	5333	7466
T20x10x10	20.0 ± 0.5	10.0 ± 0.5	10.0 ± 0.5	4.7123	0.5000	2.3561	3333	6666	9333
T22x14x6.5	22.0 ± 0.5	14.0 ± 0.5	6.5 ± 0.5	5.6548	0.2600	1.4702	1444	2888	4044
T22x14x8	22.0 ± 0.5	14.0 ± 0.5	8.0 ± 0.5	5.6548	0.3200	1.8095	1777	3555	4977
T22x14x12.7	22.0 ± 0.5	14.0 ± 0.5	12.7 ± 0.5	5.6548	0.5080	2.8726	2822	5644	7902
T25x15x8	25.0 ± 0.5	15.0 ± 0.5	8.0 ± 0.5	6.2831	0.4000	2.5132	2000	4000	5600
T25x15x10	25.0 ± 0.5	15.0 ± 0.5	10.0 ± 0.5	6.2831	0.5000	3.1415	2500	5000	7000
T25x15x13	25.0 ± 0.5	15.0 ± 0.5	13.0 ± 0.5	6.2831	0.6500	4.0840	3250	6500	9100
T25x15x15	25.0 ± 0.5	15.0 ± 0.5	15.0 ± 0.5	6.2831	0.7500	4.7123	3750	7500	10500
T28x18x8	28.0 ± 0.8	18.0 ± 0.8	8.0 ± 0.8	7.2256	0.4000	2.8902	1730	3478	4869
T28x18x16	28.0 ± 0.8	18.0 ± 0.8	16.0 ± 0.8	7.2256	0.8000	5.7805	3478	6857	9739
T31x19x13	31.0 ± 0.8	19.0 ± 0.8	13.0 ± 0.8	7.8540	0.7800	6.1261	3120	6240	8736
T31x19x16	31.0 ± 0.8	19.0 ± 0.8	16.0 ± 0.8	7.8540	0.9600	7.5398	3840	7680	10752
T35.6x25.4x12.7	35.6 ± 0.8	12.7 ± 0.8	12.7 ± 0.8	9.5818	0.6477	6.2061	2123	4247	5946
T35.6x25.4x15	35.6 ± 0.8	15.0 ± 0.8	15.0 ± 0.3	9.5818	0.7650	7.3301	2508	5016	7022



1. Material:

A2G A5N B-7 B-18

2. Ordering Code:

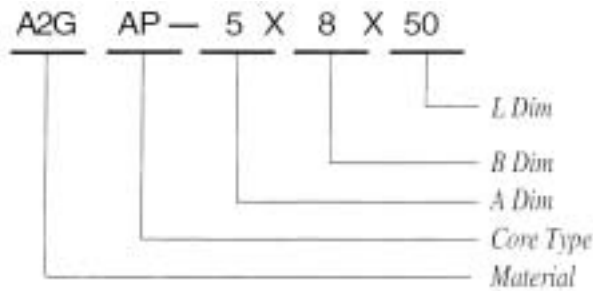

3. Shape:

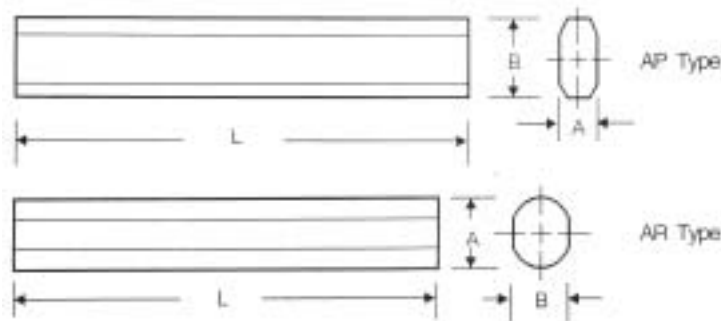

4. Dimensions: (m/m)

CORES	A	B	L
AP-1.9x7.8x49	1.9 ± 0.15	7.8 ± 0.3	49.0 ± 1.0
AP-2x8x40	2.0 ± 0.15	8.0 ± 0.3	40.0 ± 1.0
AP-2.5x8x40	2.5 ± 0.2	8.0 ± 0.3	40.0 ± 1.0
AP-2.8x8x46	2.8 ± 0.2	8.0 ± 0.3	46.0 ± 1.0
AP-3x7.5x45	3.0 ± 0.3	7.5 ± 0.3	45.0 ± 1.0
AP-3x8x35	3.0 ± 0.3	8.0 ± 0.3	35.0 ± 1.0
AP-4x8x45	4.0 ± 0.3	8.0 ± 0.3	45.0 ± 1.0
AP-4x10x50	4.0 ± 0.3	10.0 ± 0.3	50.0 ± 1.0
AP-4x12x60	4.0 ± 0.3	12.0 ± 0.3	60.0 ± 1.0
AP-5x8x50	5.0 ± 0.3	8.0 ± 0.3	50.0 ± 1.0
AP-5x13x80	5.0 ± 0.3	13.0 ± 0.3	80.0 ± 1.2
AP-6x10x42	6.0 ± 0.3	10.0 ± 0.3	42.0 ± 1.0
AP-6x12x53	6.0 ± 0.3	12.0 ± 0.3	53.0 ± 1.0

CORES	A	B	L
AR-8x50	8.0 ± 0.3	7.0 ± 0.3	50.0 ± 1.0
AR-8x60	8.0 ± 0.3	7.0 ± 0.3	60.0 ± 1.0
AR-8x80	8.0 ± 0.3	7.0 ± 0.3	80.0 ± 1.0
AR-8x100	8.0 ± 0.3	7.0 ± 0.3	100.0 ± 1.0
AR-8x140	8.0 ± 0.3	7.0 ± 0.3	140.0 ± 1.0
AR-9.5x57	9.5 ± 0.3	8.5 ± 0.3	57.0 ± 1.0
AR-10x21	10.0 ± 0.3	9.0 ± 0.3	21.0 ± 1.0
AR-10x30	10.0 ± 0.3	9.0 ± 0.3	30.0 ± 1.0
AR-10x50	10.0 ± 0.3	9.0 ± 0.3	50.0 ± 1.0
AR-10x60	10.0 ± 0.3	9.0 ± 0.3	60.0 ± 1.0
AR-10x100	10.0 ± 0.3	9.0 ± 0.3	100.0 ± 1.2
AR-10x120	10.0 ± 0.3	9.0 ± 0.3	120.0 ± 1.0
AR-10x200	10.0 ± 0.3	9.0 ± 0.3	200.0 ± 1.0

1. Material:

A-5 B-15 B-18



2. Ordering Code:

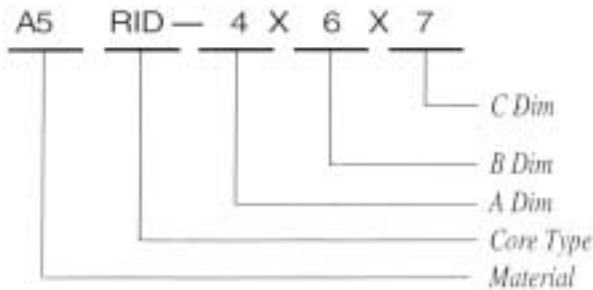

3. Shape:

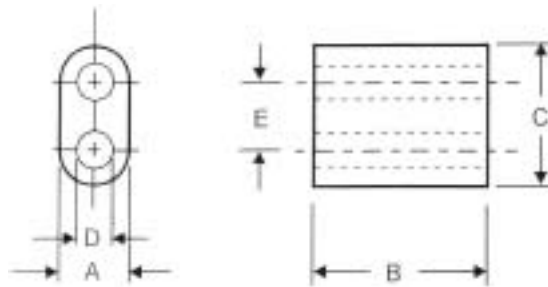

4. Dimensions: (m/m)

CORES	A	B	C	ØD
RID 1.9x1.45x3.35	1.9 ± 0.2	1.45 ± 0.15	3.35 ± 0.2	0.76 ± 0.15
RID 2.6x4x5.3	2.6 ± 0.2	4.0 ± 0.2	5.3 ± 0.2	1.0 ± 0.15
RID 3x2x5	3.0 ± 0.2	2.0 ± 0.2	5.0 ± 0.2	1.2 ± 0.15
RID 3x5x5	3.0 ± 0.2	5.0 ± 0.3	5.0 ± 0.2	1.2 ± 0.15
RID 3.5x5x6.3	3.5 ± 0.2	5.0 ± 0.3	6.3 ± 0.3	1.8 ± 0.15
RID 4x3.2x7	4.0 ± 0.2	3.2 ± 0.2	7.0 ± 0.3	2.0 ± 0.15
RID 4x6x7	4.0 ± 0.2	6.0 ± 0.3	7.0 ± 0.3	2.0 ± 0.15
RID 6.5x4x12	6.5 ± 0.3	4.0 ± 0.2	12.0 ± 0.4	3.8 ± 0.25
RID 6.8x4x11.8	6.8 ± 0.3	4.0 ± 0.2	11.8 ± 0.4	3.8 ± 0.25
RID 7.5x4x13.5	7.5 ± 0.3	4.0 ± 0.2	13.5 ± 0.5	3.8 ± 0.25
RID 7.5x14x13.5	7.5 ± 0.3	14.0 ± 0.52	13.5 ± 0.5	3.8 ± 0.25
RID 8x7x15	8.0 ± 0.3	7.0 ± 0.3	15.0 ± 0.5	5.0 ± 0.25
RID 8x14x15	8.0 ± 0.3	1.40 ± 0.5	15.0 ± 0.5	5.0 ± 0.25

1. Material:

A3 B-15

2. Ordering Code:

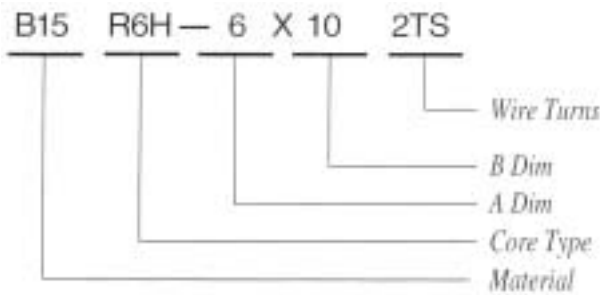

3. Core Shape:

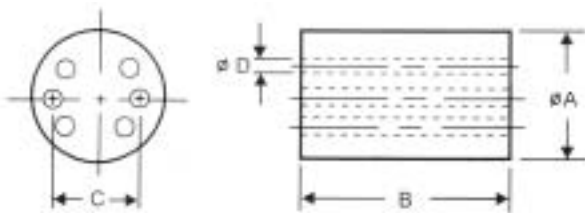

4. Dimensions: (m/m)

A	6.0 ± 0.2
B	10.0 ± 0.4
C	3.4 ± 0.15
D	0.85 ± 0.1

5. Impedance (Ω)

Impedance is measured on AC & B-15 material with the HP-4193A test meter.



Fig.1



Fig.2



Fig.3

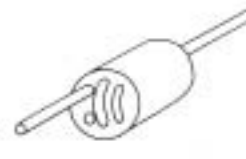

Fig.4



Fig.5

Fig.	TURNS	A3			B-15		
		10MHz	50MHz	100MHz	10MHz	50MHz	100MHz
1	1 ½	130	320	450	180	350	380
2	2 X 1 ½	130	320	450	180	350	380
3	2	200	520	580	260	500	480
4	2 ½	250	750	700	360	700	580
5	3	320	900	700	450	800	580

1. Material:

B-8

2. Ordering Code:

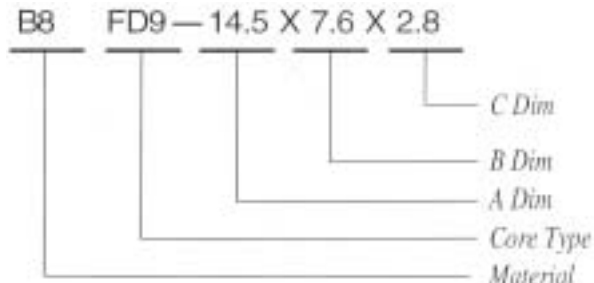

3. Core Shape:



4. Dimensions: (m/m)

CORES	A	B	C	D	E	F	MIN. IMPEDANCE (OHM)	
							25MHz	100MHz
FH-15.4x4.35x8.4	14.5 ± 0.5	7.6 ± 0.5	2.8 ± 0.1	2.74 ± 0.08	2.84 ± 0.08	1.57 ^{+0.15} ₋₀	20	50
FH-20x5.1x9.9	22.65 ± 0.5	7.6 ± 0.5	2.8 ± 0.1	2.77 ± 0.08	2.84 ± 0.08	1.57 ^{+0.15} ₋₀	20	50
FH-29.2x7.7x14.4	36.4 ± 0.5	7.6 ± 0.5	2.8 ± 0.1	2.77 ± 0.08	2.84 ± 0.08	1.57 ^{+0.15} ₋₀	20	50
FH-33.3x8.25x16.4	53.08 ± 0.5	7.7 ± 0.5	2.8 ± 0.1	2.77 ± 0.08	2.84 ± 0.08	1.57 ^{+0.15} ₋₀	20	50
FH-24x12x14	13.6 ± 0.5	9.5 ± 0.3	2.2 ± 0.1	2.27 ± 0.08	2.54 ± 0.15	1.0 ^{+0.15} ₋₀	18	45
FH-28.5x7.5x15	22.6 ± 0.4	9.5 ± 0.3	2.2 ± 0.1	2.29 ± 0.15	2.54 ± 0.15	1.0 ^{+0.15} ₋₀	18	45
FH-30x9.4x18.7	36.6 ± 0.3	9.5 ± 0.3	2.2 ± 0.1	2.29 ± 0.15	2.54 ± 0.15	1.0 ^{+0.15} ₋₀	18	45

5. Typical Performance Data:

- B8FH- 15.4 x 4.35 x 8.4

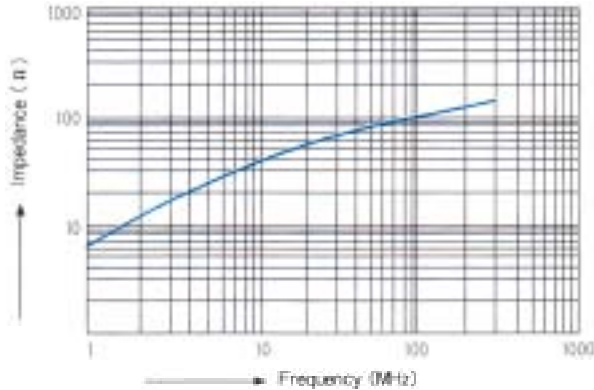

TEST WIRE: 2 UEW 0.8 X 220mm 1/2 Ts
TEST METER: HP4191A

- B8FH- 28.5 x 7.5 x 15

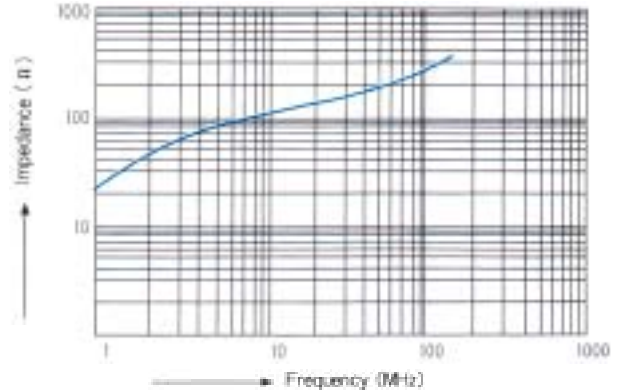

TEST WIRE: 2 UEW 0.8 X 220mm 1/2 Ts
TEST METER: HP4191A

- B8FH- 20 x 5.1 x 9.9

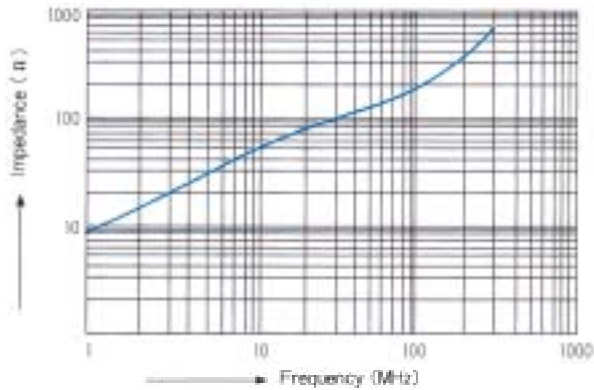

TEST WIRE: 2 UEW 0.8 X 220mm 1/2 Ts
TEST METER: HP4191A

- B8FH- 30 x 9.4 x 18.7

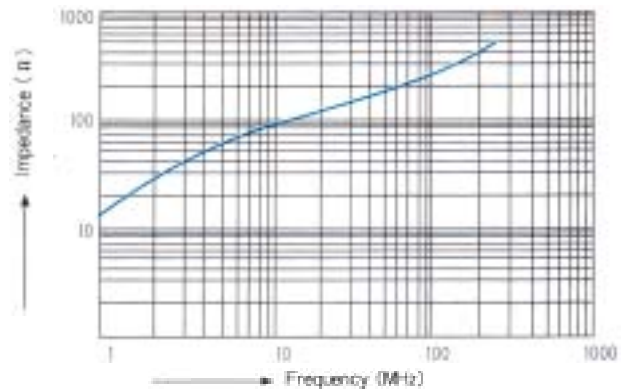

TEST WIRE: 2 UEW 0.8 X 220mm 1/2 Ts
TEST METER: HP4191A

- B8FH- 24 x 12 x 14

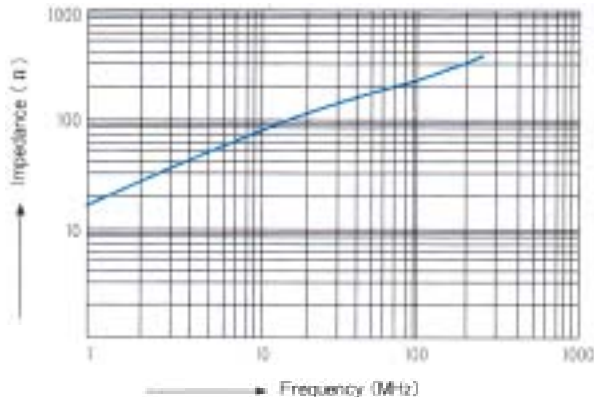

TEST WIRE: 2 UEW 0.8 X 220mm 1/2 Ts
TEST METER: HP4191A

- B8FH- 29.7 x 13 x 25.9

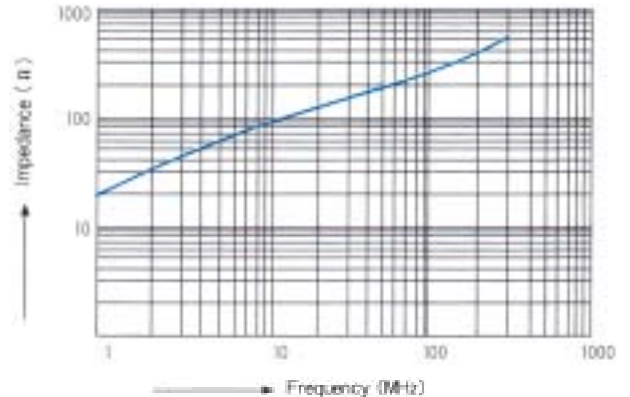

TEST WIRE: 2 UEW 0.8 X 220mm 1/2 Ts
TEST METER: HP4191A

1. Material:

B-8

2. Ordering Code:

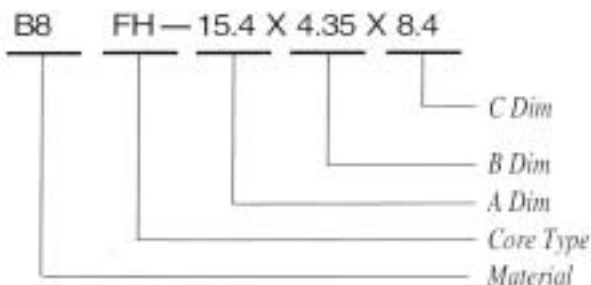

3. Core Shape:

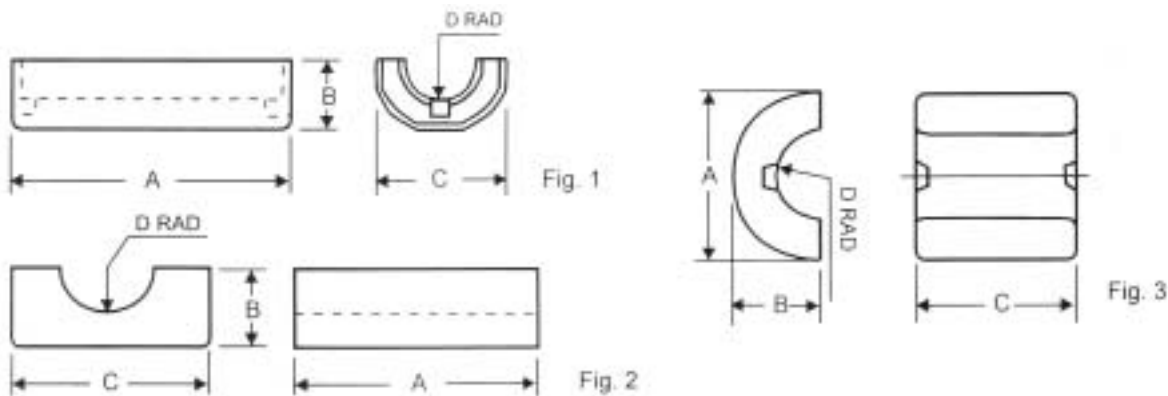

4. Dimensions: (m/m)

CORES	A	B	C	D	Fig.	MIN. IMPEDANCE (OHM)	
						25MHz	100MHz
FH-15.4x4.35x8.4	15.4 ± 0.5	4.35 ± 0.3	8.4 ± 0.4	1.9 ± 0.15	1	50	80
FH-20x5.1x9.9	20.0 ± 0.5	5.1 ± 0.3	9.9 ± 0.4	2.65 ± 0.15	1	70	140
FH-29.2x7.7x14.4	29.2 ± 0.5	7.6 ~ 7.8	14.4 ± 0.5	3.8 ± 0.15	1	100	180
FH-33.3x8.25x16.4	33.3 ± 0.6	8.2 ~ 8.4	16.4 ± 0.5	4.65 ± 0.15	1	105	190
FH-24x12x14	24.0 ± 0.6	12.0 ± 0.4	14.0 ± 0.5	5.7 ± 0.3	3	50	100
FH-28.5x7.5x15	28.5 ± 0.75	7.5 ± 0.3	15.0 ± 0.5	3.3 ± 0.15	2	130	200
FH-30x9.4x18.7	30.0 ± 0.75	9.4 ± 0.3	18.7 ± 0.7	5.1 ± 0.15	2	105	180
FH-29.7x13x25.9	29.7 ± 0.75	13.0 ± 0.3	25.9 ± 0.7	6.5 ± 0.15	2	120	200

4. Typical Performance Date: (Cont.)

• FP- 49.6 x125 x 6.5

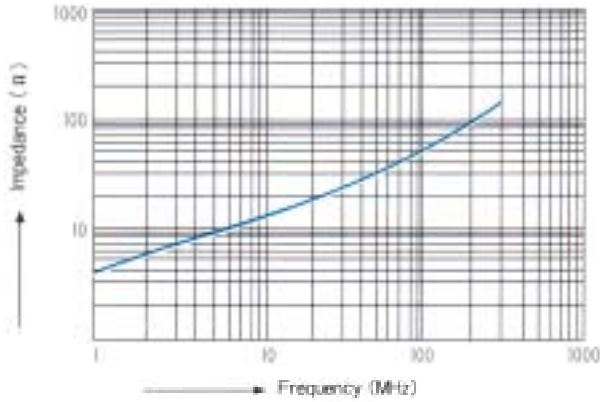

TEST WIRE: 2 UEW 0.8 X 220mm 1/2 Ts
TEST METER: HP4191A

• FI- 63.5 x 28.5 x 6.35

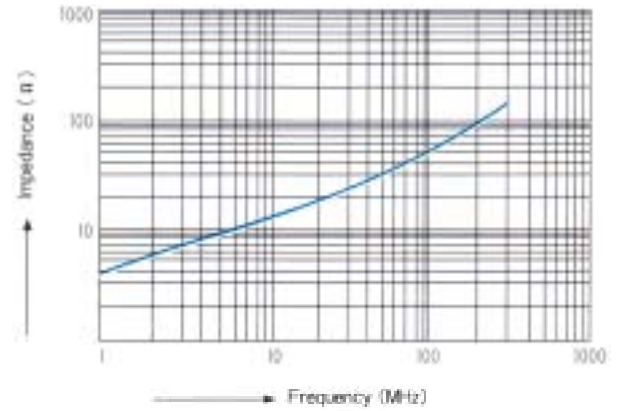

TEST WIRE: 2 UEW 0.8 X 220mm 1/2 Ts
TEST METER: HP4191A

5. Dimensions: (m/m)

CORES	A	B	C	D	E	Fig.	MIN. IMPEDANCE (OHM)	
							25MHz	100MHz
FP-16x12x4.5	16.0 ± 0.5	12.0 ± 0.4	4.5 ± 0.3	11.5 ± 0.3	0.85 ± 0.15	1	20	50
FP-23.5x15x6.3	23.5 ± 0.8	15.0 ± 0.5	6.3 ± 0.4	19.0 ± 0.5	1.0 ± 0.2	1	20	50
FP-25x12x5	25.0 ± 0.8	12.0 ± 0.4	5.0 ± 0.3	21.0 ± 0.5	0.85 ± 0.15	1	20	50
FP-32x9.5x6.5	32.0 ± 0.8	9.5 ± 0.3	6.5 ± 0.4	28.0 ± 0.8	2.8 ± 0.42	1	15	45
FP-33x11.5x7.5	33.0 ± 0.8	11.5 ± 0.3	7.5 ± 0.4	28.0 ± 0.8	2.8 ± 0.2	1	25	60
FP-33x15x8.45	33.0 ± 0.8	15.0 ± 0.5	8.45 ± 0.4	28.0 ± 0.8	3.5 ± 0.3	1	25	60
FP-33.5x12x6.5	33.5 ± 1.0	12.0 ± 0.3	6.5 ± 0.4	27.0 ± 0.7	1.5 ± 0.2	1	20	40
FP-x12x6.540	40.0 ± 1.0	12.0 ± 0.3	6.5 ± 0.4	34.8 ± 0.8	1.3 ± 0.2	1	15	35
FP-45.2x12x6.5	45.2 ± 1.0	12.0 ± 0.3	6.5 ± 0.4	40.0 ± 0.8	1.3 ± 0.2	1	15	35
FP-46.5x10x6.5	46.5 ± 1.0	10.0 ± 0.3	6.5 ± 0.4	40.0 ± 0.8	1.3 ± 0.2	1	25	60
FP-49.6x12x6.5	49.6 ± 1.0	12.0 ± 0.3	6.5 ± 0.4	44.0 ± 0.8	1.3 ± 0.2	1	15	35
FP-57.6x12x6.5	57.6 ± 1.0	12.0 ± 0.3	6.5 ± 0.4	52.0 ± 0.8	1.5 ± 0.2	1	15	40
FPL-28x14.6x7.7	28 ± 1.0	14.6 ± 0.5	7.7 ± 0.4	23.0 ± 0.5	1.5 ± 0.3	2	30	75
FI-45.1x28.5x4.5	45.1 ± 1.0	28.5 ± 0.8	4.5 ± 0.5	34.4 ± 0.8	0.6 ± 0.2	3	45	80
FI-45.1x28.5x6.35	45.1 ± 1.0	28.5 ± 0.8	6.35 ± 0.5	34.4 ± 0.8	0.8 ± 0.2	3	50	90
FI-63.5x28.5x6.35	36.5 ± 1.5	28.5 ± 0.8	6.35 ± 0.5	52.1 ± 1.5	0.8 ± 0.2	3	40	80
FI-76.2x28.5x6.4	76.2 ± 1.5	28.5 ± 0.8	6.40 ± 0.5	65.3 ± 1.5	0.8 ± 0.2	3	65	150

1. Material:

B-8 B-15

2. Ordering Code:

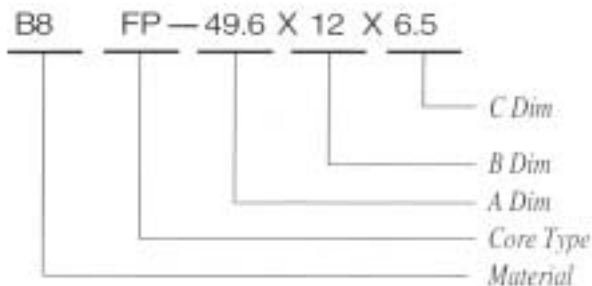

3. Core Shape:

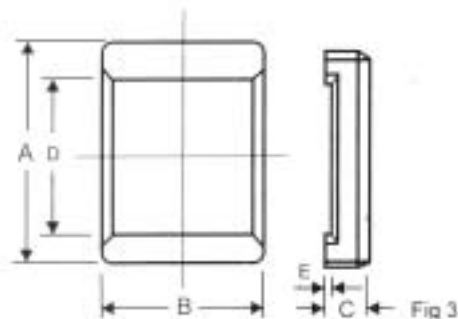
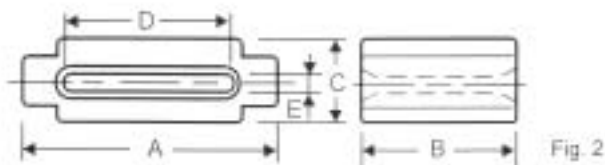
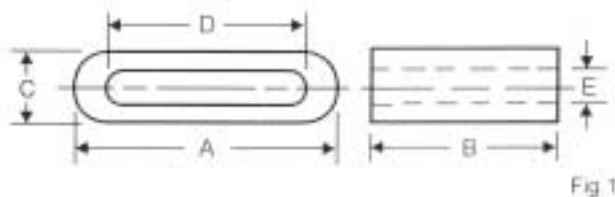

4. Typical Performance Date:

- FP- 33 x 11.5 x 7.5

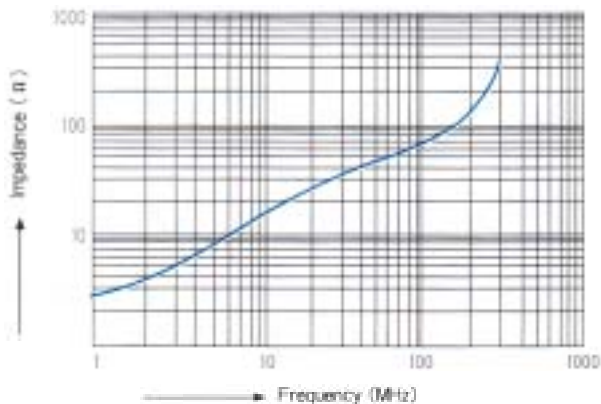

TEST WIRE: 2 UEW .65 X 160mm 1/2 Ts
TEST METER: HP4191A

- FP- 45.2 x 12 x 6.5

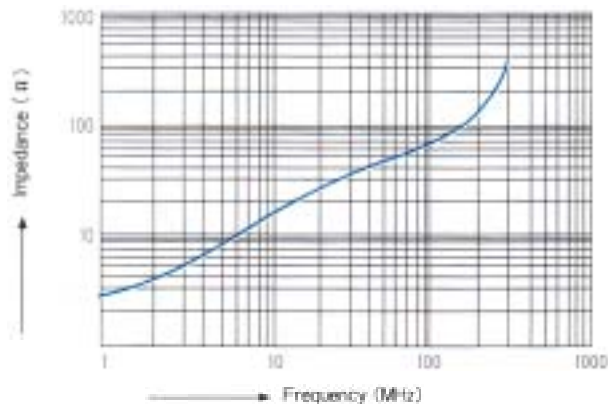

TEST WIRE: 2 UEW 0.8 X 220mm 1/2 Ts
TEST METER: HP4191A

- B15T- 18.3 x 10 x 10

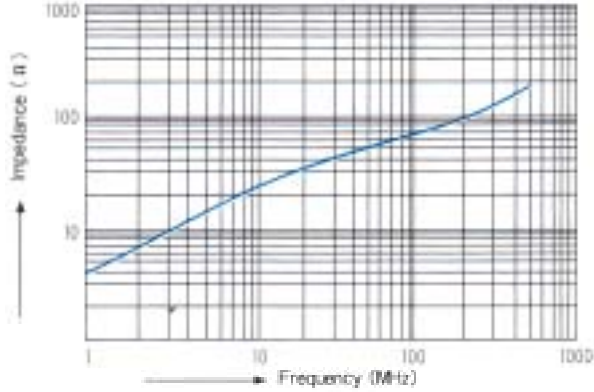

TEST WIRE: 2 UEW 1.0 X 63mm 1/2 Ts
TEST METER: HP4191A

- B15T- 20.5 x 10 x 10.3

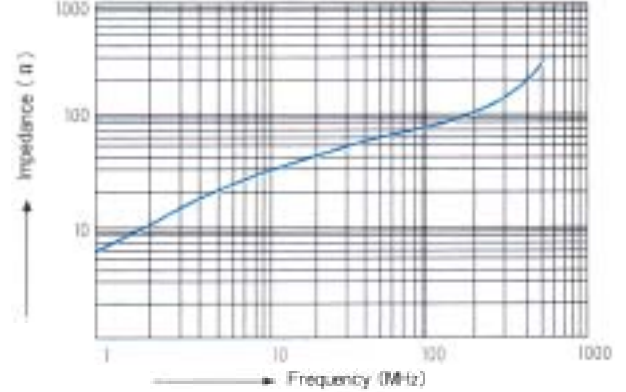

TEST WIRE: 2 UEW 1.0 X 63mm 1/2 Ts
TEST METER: HP4191A

- B8T- 22.5 x 6.4 x 13.8

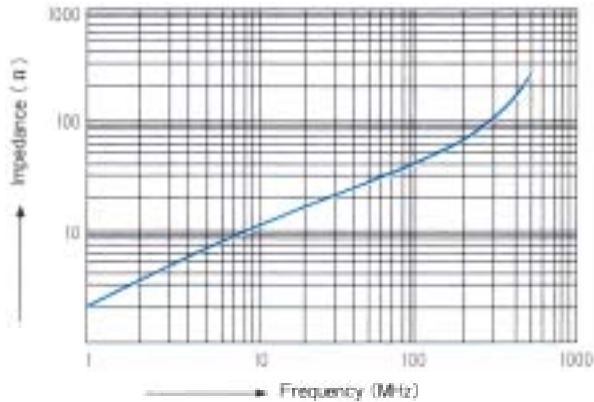

TEST WIRE: 2 UEW 1.0 X 63mm 1/2 Ts
TEST METER: HP4191A

- B8T- 25 x 12 x 15

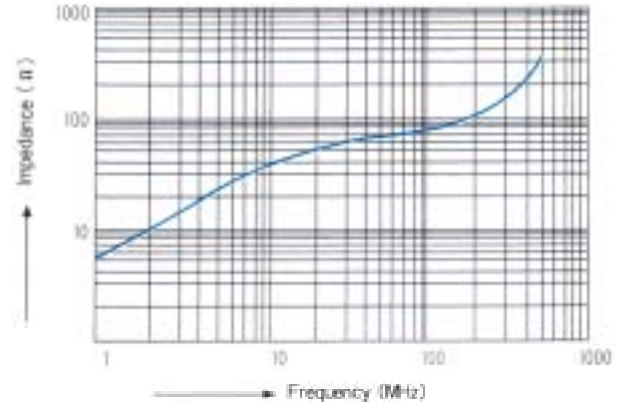

TEST WIRE: 2 UEW 1.0 X 63mm 1/2 Ts
TEST METER: HP4191A

- B8T- 28 x 7.5 x 16

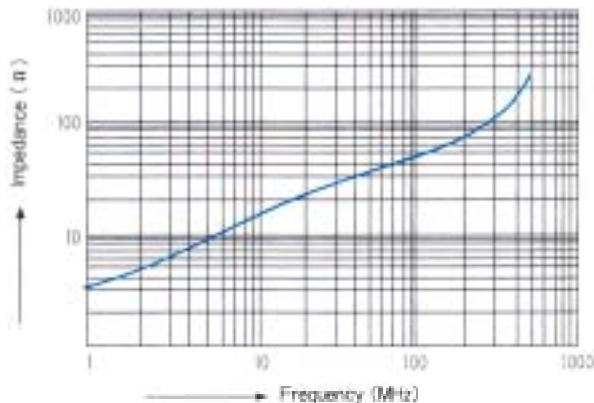

TEST WIRE: 2 UEW 1.0 X 63mm 1/2 Ts
TEST METER: HP4191A

- B8T- 31 x 8 x 19

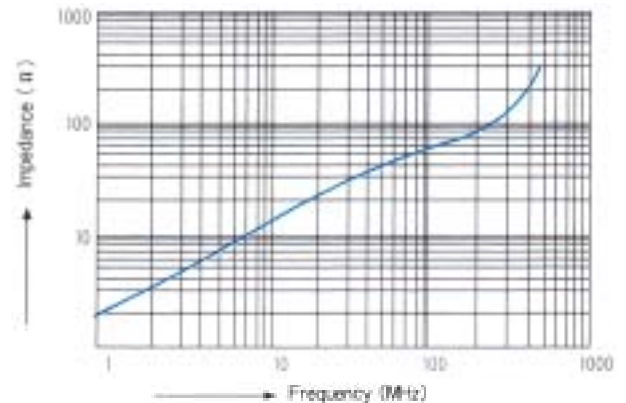

TEST WIRE: 2 UEW 1.0 X 63mm 1/2 Ts
TEST METER: HP4191A

5. Typical Performance Data:

- B15T- 8 x 4 x 4

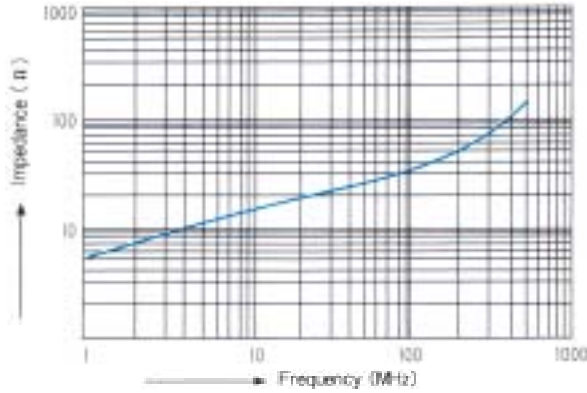

TEST WIRE: 2 UEW 1.0 X 63mm 1/2 Ts
TEST METER: HP4191A

- B15T- 9.5 x 4.5 x 4.75

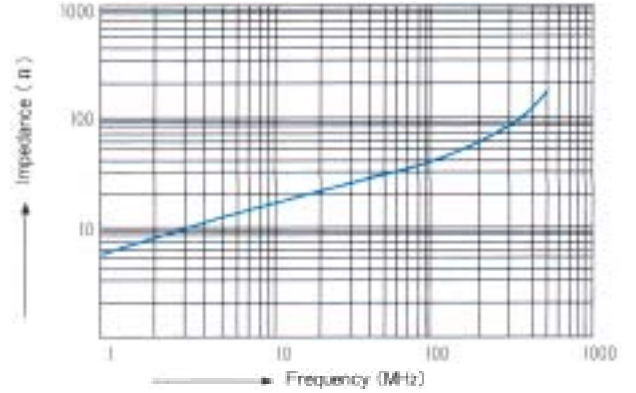

TEST WIRE: 2 UEW 1.0 X 63mm 1/2 Ts
TEST METER: HP4191A

- B15T- 12 x 5.5 x 7

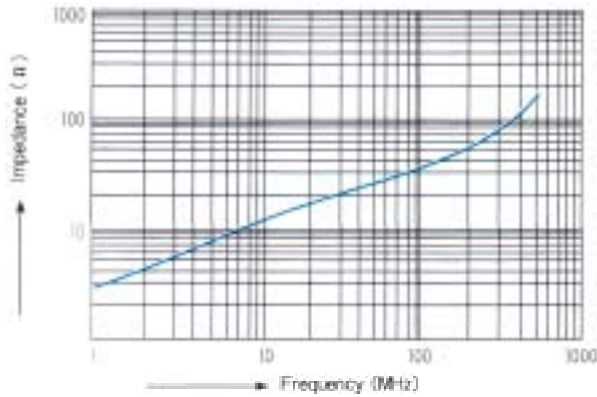

TEST WIRE: 2 UEW 1.0 X 63mm 1/2 Ts
TEST METER: HP4191A

- B15T- 12.7 x 6.35 x 7.93

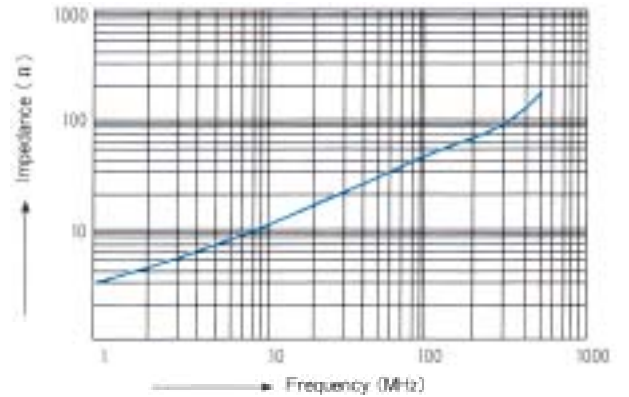

TEST WIRE: 2 UEW 1.0 X 63mm 1/2 Ts
TEST METER: HP4191A

- B15T- 16.2 x 7.5 x 9.1

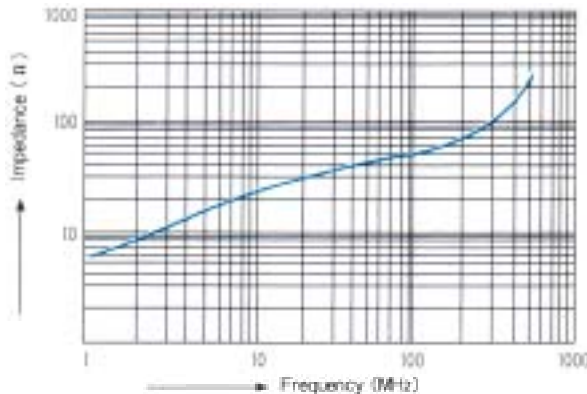

TEST WIRE: 2 UEW 1.0 X 63mm 1/2 Ts
TEST METER: HP4191A

- B15T- 17.5 x 12.7 x 9.5

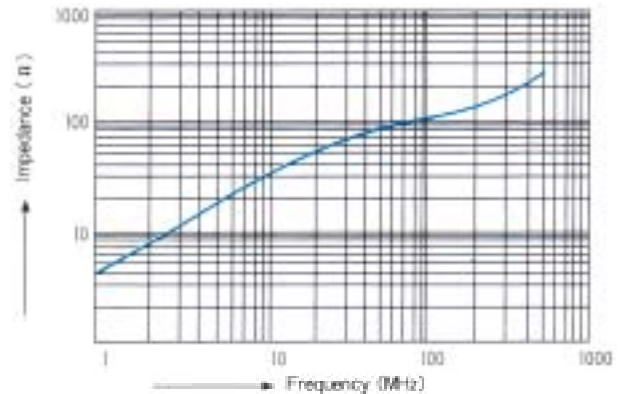

TEST WIRE: 2 UEW 1.0 X 63mm 1/2 Ts
TEST METER: HP4191A

CORES	A	B	C	MIN. IMPEDANCE (OHM)	
				25MHz	100MHz
B15 T12.1x11x8.6	12.1 ± 0.4	11.0 ± 0.3	8.6 ± 0.3	30	63
B15 T12.7x6.35x7.93	12.7 ± 0.4	6.35 ± 0.3	7.93 ± 0.3	25	60
B15 T13x8x8.2	13.0 ± 0.4	8.0 ± 0.3	8.2 ± 0.3	28	60
B15 T13.5x4x7	13.5 ± 0.4	4.0 ± 0.25	7.0 ± 0.3	22	58
B15 T13.5x5x7	13.5 ± 0.4	5.0 ± 0.3	7.0 ± 0.3	25	60
B8 T14.2x7x7	14.2 ± 0.4	7.0 ± 0.3	7.0 ± 0.3	25	55
B8 T16x8x9.8	16.0 ± 0.4	8.0 ± 0.3	9.8 ± 0.3	25	55
B8 T16x8x12	16.0 ± 0.4	8.0 ± 0.3	12.0 ± 0.4	22	50
B15 T16x10x10	16.0 ± 0.4	10.0 ± 0.3	10.0 ± 0.3	33	65
B15 T16.2x4.8x9.1	16.2 ± 0.4	4.8 ± 0.3	9.1 ± 0.3	22	58
B15 T16.2x7.5x9.1	16.2 ± 0.4	7.5 ± 0.3	9.1 ± 0.3	30	65
B15 T17.5x5x9.5	17.5 ± 0.5	5.0 ± 0.3	9.5 ± 0.3	23	58
B15 T17.5x6.4x9.5	17.5 ± 0.5	6.4 ± 0.3	9.5 ± 0.3	28	63
B30 T17.5x8x9.5	17.5 ± 0.5	8.0 ± 0.3	9.5 ± 0.3	30	60
B8 T17.5x12.7x9.5	17.5 ± 0.5	12.7 ± 0.4	9.5 ± 0.3	40	80
B15 T17.5x13.5x9.5	17.5 ± 0.5	13.5 ± 0.4	9.5 ± 0.3	45	86
B15 T17.5x15x9.5	17.5 ± 0.5	15.0 ± 0.4	9.5 ± 0.3	55	92
B15 T18.3x7x10	18.3 ± 0.5	7.0 ± 0.3	10.0 ± 0.3	30	65
B15 T18.3x10x10	18.3 ± 0.5	10.0 ± 0.3	10.0 ± 0.3	40	75
B15 T18.4x6.2x11	18.4 ± 0.5	6.2 ± 0.3	11.0 ± 0.3	25	60
B15 T18.4x12.5x9.5	18.4 ± 0.5	12.5 ± 0.4	9.5 ± 0.3	50	88
B15 T20.5x5x10.3	20.5 ± 0.5	5.0 ± 0.3	10.0 ± 0.3	25	60
B15 T20.5x8x10.3	20.5 ± 0.5	8.0 ± 0.3	10.3 ± 0.3	40	75
B15 T20.5x10x10.3	20.5 ± 0.5	10.0 ± 0.3	10.3 ± 0.3	40	80
B8 T22.5x6.4x13.8	22.5 ± 0.5	6.4 ± 0.3	13.8 ± 0.4	20	55
B15 T22.5x8.5x13.8	22.5 ± 0.5	8.5 ± 0.3	13.8 ± 0.4	30	65
B15 T22.5x13.5x13.8	22.5 ± 0.5	13.5 ± 0.4	13.8 ± 0.4	40	85
B15 T23x9.5x12.5	23.0 ± 0.5	9.5 ± 0.3	12.5 ± 0.4	40	75
B8 T25x12x15	25.0 ± 0.6	12.0 ± 0.4	15.0 ± 0.4	40	80
B30 T26x8x16	26.0 ± 0.6	8.0 ± 0.3	16.0 ± 0.4	26	60
B15 T28x20x13.8	28.0 ± 0.7	20.0 ± 0.5	13.8 ± 0.4	85	135
B15 T28x7.5x16	28.0 ± 0.7	7.5 ± 0.3	16.0 ± 0.4	30	65
B15 T29x14x19	29.0 ± 0.7	14.0 ± 0.4	19.0 ± 0.5	40	80
B15 T31x7x19	31.0 ± 0.8	7.0 ± 0.3	19.0 ± 0.5	25	63
B15 T31x8x19	31.0 ± 0.8	8.0 ± 0.3	19.0 ± 0.5	28	65
B15 T47x14x29.5	47.0 ± 1.0	14.0 ± 0.5	29.5 ± 0.6	46	90



1. Material:

B-8 B-10 B-12 B-15 B-30

2. Ordering Code:

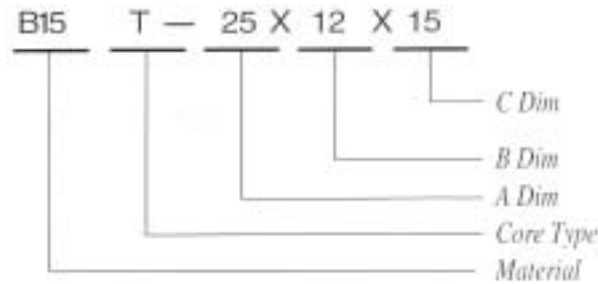

3. Core Shape:

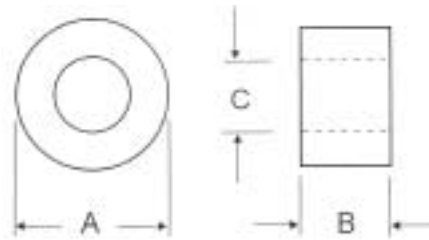

4. Dimensions: (m/m)

CORES	A	B	C	MIN. IMPEDANCE (OHM)	
				25MHz	100MHz
B15 T4x1.5x2	4.0 ± 0.25	1.5 ± 0.2	2.0 ± 0.2	12	30
B15 T6x2x3	6.0 ± 0.3	2.0 ± 0.2	3.0 ± 0.25	15	40
B15 T7.75x4.25x3.8	7.75 ± 0.3	4.25 ± 0.25	3.8 ± 0.25	20	55
B15 T8x4x4	8.0 ± 0.3	4.0 ± 0.25	4.0 ± 0.25	20	55
B15 T9.3x3.2x6.3	9.3 ± 0.3	3.2 ± 0.25	6.3 ± 0.3	18	50
B15 T9.5x4.5x4.75	9.5 ± 0.3	4.5 ± 0.3	4.75 ± 0.3	20	55
B30 T9.66x3.3x5	9.66 ± 0.3	3.3 ± 0.25	5.0 ± 0.3	17	50
B15 T9.66x5.8x6.35	9.66 ± 0.3	5.8 ± 0.3	6.35 ± 0.3	20	50
B15 T10x5x5.1	10.0 ± 0.3	5.0 ± 0.3	5.1 ± 0.3	25	60
B15 T10x4x6	10.0 ± 0.3	4.0 ± 0.25	6.0 ± 0.3	20	55
B15 T10x5x7	10.0 ± 0.3	5.0 ± 0.3	7.0 ± 0.3	18	55
B15 T11x9x5	11.0 ± 0.4	9.0 ± 0.3	5.0 ± 0.3	40	75
B15 T11.8x8x7.3	11.8 ± 0.4	8.0 ± 0.3	7.3 ± 0.3	30	60
B15 T12x4x6	12.0 ± 0.4	4.0 ± 0.25	6.0 ± 0.3	22	58
B15 T12x6x6	12.0 ± 0.4	6.0 ± 0.3	6.0 ± 0.3	28	60
B8 T12x5.5x7	12.0 ± 0.4	5.5 ± 0.3	7.0 ± 0.3	22	60
B15 T12.1x8x8.6	12.1 ± 0.4	8.0 ± 0.3	8.6 ± 0.3	22	58

- B8RH- 14.3 x 28.5 x 6.35

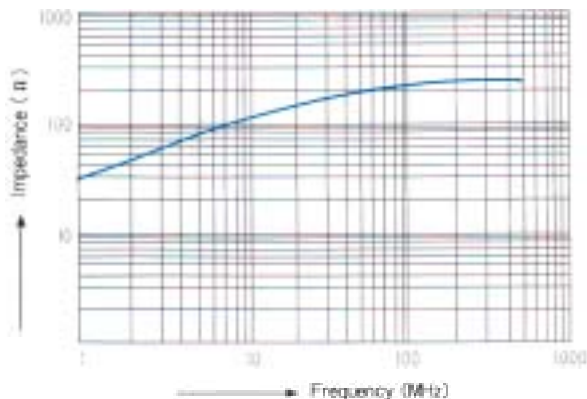

TEST WIRE: 2 UEW 1.0 X 63mm 1/2 Ts
TEST METER: HP4191A

- B15RH- 16 x 28 x 9

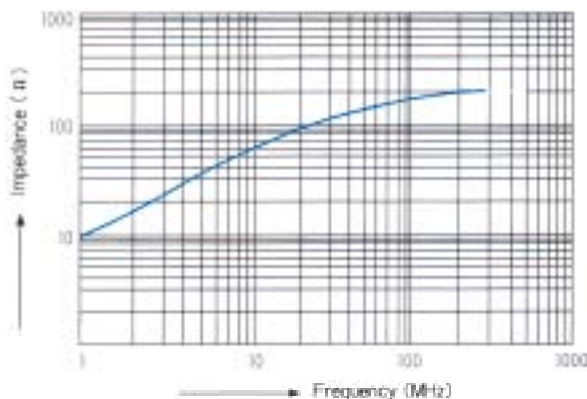

TEST WIRE: 2 UEW 1.0 X 63mm 1/2 Ts
TEST METER: HP4191A

- B8RH- 14.3 x 28.5 x 7

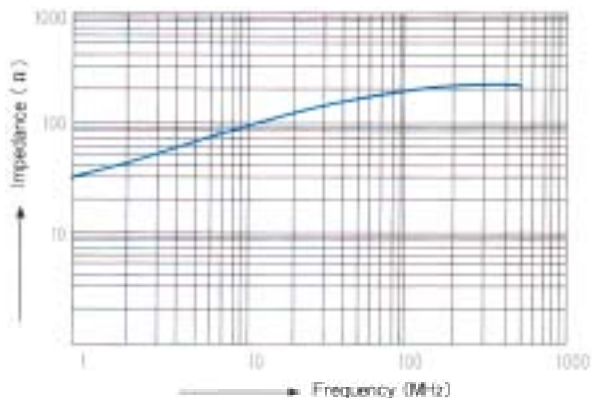

TEST WIRE: 2 UEW 1.0 X 63mm 1/2 Ts
TEST METER: HP4191A

- B8RH- 17.5 x 28.5 x 9.5

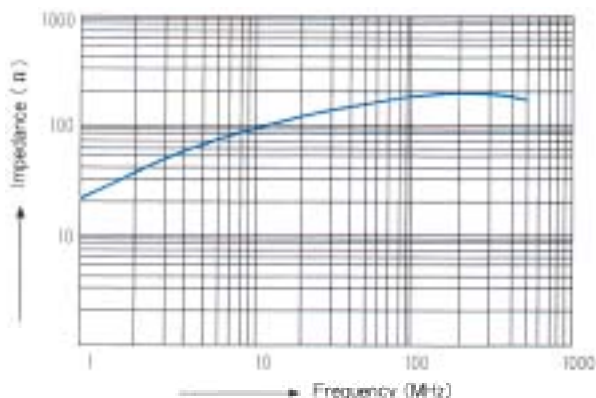

TEST WIRE: 2 UEW 1.0 X 63mm 1/2 Ts
TEST METER: HP4191A

- B15RH- 16 x 17 x 9

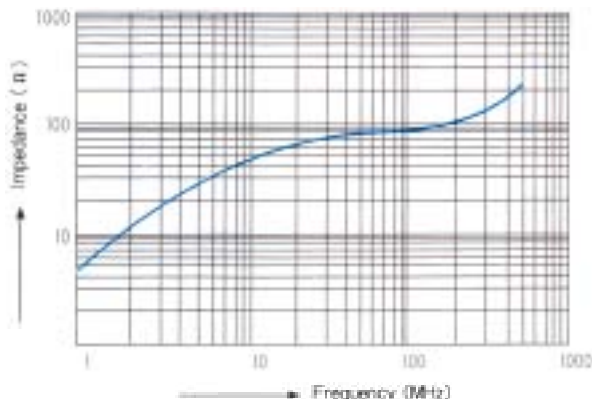

TEST WIRE: 2 UEW 1.0 X 63mm 1/2 Ts
TEST METER: HP4191A

- B8RH- 28.3 x 28.5 x 13.8

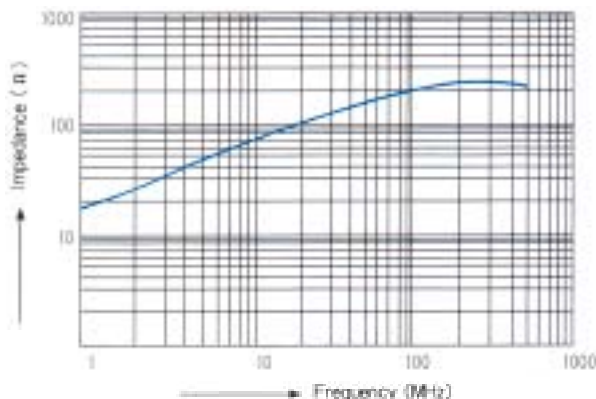

TEST WIRE: 2 UEW 1.0 X 63mm 1/2 Ts
TEST METER: HP4191A

5. Typical Performance Data

- B15RH- 3.5 x 4.7 x 0.8

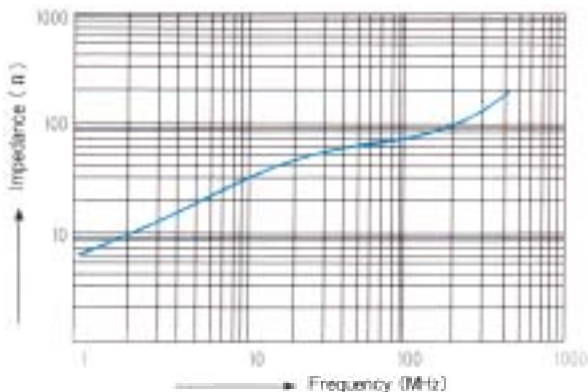

TEST WIRE: 2 UEW 0.4 X 63mm 1/2 Ts
TEST METER: HP4191A

- B8RH- 12 x 15 x 7.3

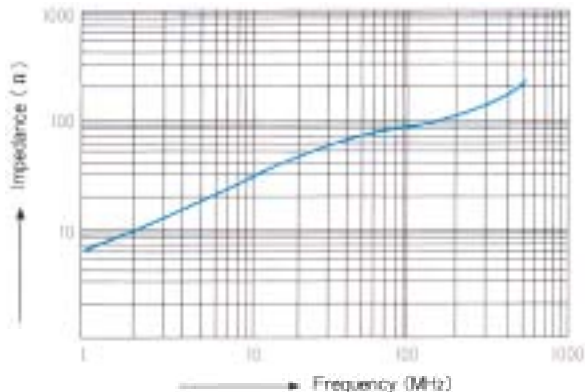

TEST WIRE: 2 UEW 1.0 X 63mm 1/2 Ts
TEST METER: HP4191A

- B15RH- 6 x 10 x 3

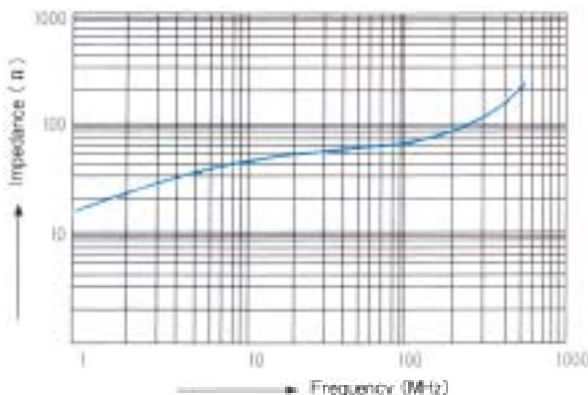

TEST WIRE: 2 UEW 1.0 X 63mm 1/2 Ts
TEST METER: HP4191A

- B15RH- 12 x 20 x 5.6

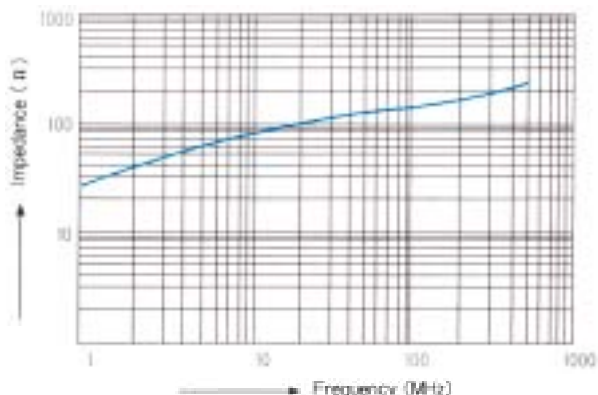

TEST WIRE: 2 UEW 1.0 X 63mm 1/2 Ts
TEST METER: HP4191A

- B15RH- 9.5 x 10 x 5

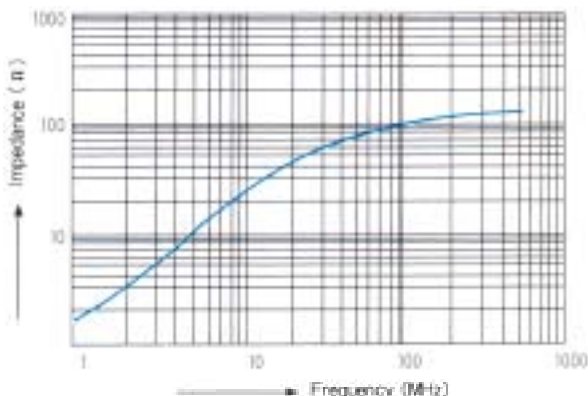

TEST WIRE: 2 UEW 1.0 X 63mm 1/2 Ts
TEST METER: HP4191A

- B15RH- 14.2 x 23.5 x 7.9

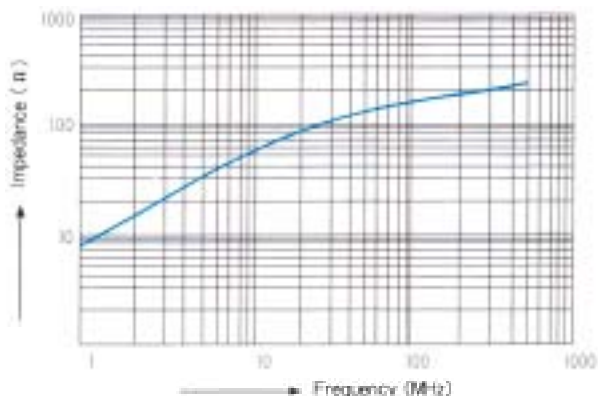

TEST WIRE: 2 UEW 1.0 X 63mm 1/2 Ts
TEST METER: HP4191A

CORES	A	B	C	MIN. IMPEDANCE (OHM)	
				25MHz	100MHz
B15 RH8x9.2x5	8.0 ± 0.3	9.2 ± 0.3	5.0 ± 0.3	30	60
B15 RH9x16x5	9.0 ± 0.3	16.0 ± 0.5	5.0 ± 0.3	60	100
B15 RH9.5x10x5	9.5 ± 0.3	10.0 ± 0.4	5.0 ± 0.3	42	80
B8 RH9.5x12.7x5	9.5 ± 0.3	12.7 ± 0.4	5.0 ± 0.3	45	88
B15 RH9.66x10.2x6.35	9.66 ± 0.3	10.2 ± 0.4	6.35 ± 0.3	30	63
B15 RH9.8x13.5x6.35	9.8 ± 0.3	13.5 ± 0.4	6.35 ± 0.3	40	75
B15 RH10x10x7	10.0 ± 0.4	10.0 ± 0.4	7.0 ± 0.3	28	60
B15 RH10.3x10.2x5.8	10.3 ± 0.4	10.2 ± 0.4	5.8 ± 0.3	40	75
B15 RH10.5x20x5.5	10.5 ± 0.4	20.0 ± 0.5	5.5 ± 0.3	80	125
B15 RH11.5x19x7.1	11.5 ± 0.4	19.0 ± 0.5	7.1 ± 0.3	60	100
B8 RH12x15x7.3	12.0 ± 0.4	15.0 ± 0.5	7.3 ± 0.15	40	85
B15 RH12x20x5.6	12.0 ± 0.4	20.0 ± 0.6	5.6 ± 0.3	100	160
B15 RH12x25.7x5.5	12.0 ± 0.4	25.7 ± 0.7	5.5 ± 0.3	130	180
B15 RH12.7x12.7x7.9	12.7 ± 0.4	12.7 ± 0.4	7.9 ± 0.3	45	80
B15 RH12.7x15x7.9	12.7 ± 0.4	15.0 ± 0.5	7.9 ± 0.3	50	85
B15 RH14.2x23.5x7.9	14.2 ± 0.5	13.5 ± 0.7	7.9 ± 0.3	88	140
B15 RH14.3x15x6.35	14.3 ± 0.5	15.0 ± 0.5	6.35 ± 0.3	70	120
B15 RH14.3x28.5x6.35	14.3 ± 0.5	28.5 ± 0.7	6.35 ± 0.3	130	190
B8 RH14.3x28.5x7	14.3 ± 0.5	28.5 ± 0.7	7.0 ± 0.3	130	180
B8 RH15.5x28.5x7.3	15.5 ± 0.5	28.5 ± 0.7	7.3 ± 0.3	130	180
B15 RH16x16x7.9	16.0 ± 0.5	16.0 ± 0.5	7.9 ± 0.3	70	110
B8 RH16x17x9	16.0 ± 0.5	17.0 ± 0.5	9.0 ± 0.4	60	100
B8 RH16x28x9	16.0 ± 0.5	28.0 ± 0.7	9.0 ± 0.4	90	160
B15 RH16x28x9.8	16.0 ± 0.5	28.0 ± 0.7	9.8 ± 0.4	88	140
B8 RH17.5x28.5x9.5	17.5 ± 0.5	28.5 ± 0.7	9.5 ± 0.4	100	150
B15 RH17.5x28.5x9.9	17.5 ± 0.5	28.5 ± 0.7	9.9 ± 0.4	100	150
B15 RH17.5x28.5x11	17.5 ± 0.5	28.5 ± 0.7	11.0 ± 0.5	90	135
B15 RH17.5x28.5x12.8	17.5 ± 0.5	28.5 ± 0.7	12.8 ± 0.5	65	100
B15 RH18.4x28.5x9.5	18.4 ± 0.5	28.5 ± 0.7	9.5 ± 0.4	120	180
B15 RH18.4x28.5x10.2	8.4 ± 0.5	28.5 ± 0.7	10.2 ± 0.4	110	160
B15 RH18.4x28.5x11	18.4 ± 0.5	28.5 ± 0.7	11.0 ± 0.5	100	150
B15 RH19.7x28.5x11.5	19.7 ± 0.5	28.5 ± 0.7	13.8 ± 0.6	100	145
B8 RH28.3x28.5x13.8	28.3 ± 0.7	28.5 ± 0.7	13.8 ± 0.6	116	200



1. Material:

B-8 B-10 B-12 B-15 B-30

2. Ordering Code:

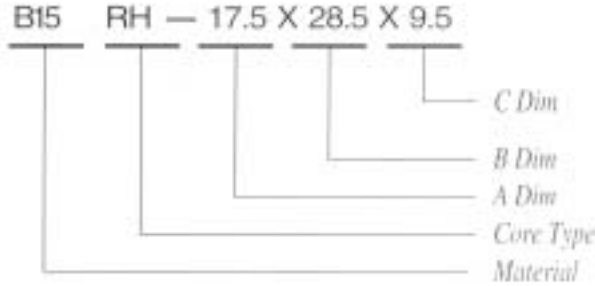

3. Core Shape:

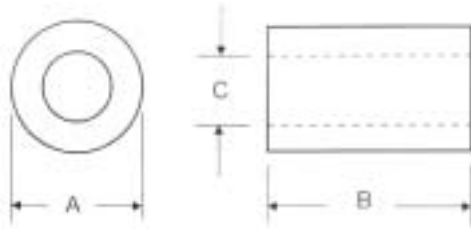

4. Dimensions: (m/m)

CORES	A	B	C	MIN. IMPEDANCE (OHM)	
				25MHz	100MHz
B15 RH3.5x3.5x0.8	3.5 ± 0.2	3.5 ± 0.2	0.8 ± 0.15	25	45
B15 RH3.5x4.7x0.8	3.5 ± 0.2	3.5 ± 0.2	3.5 ± 0.2	30	50
B15 RH3.5x4x1.2	3.5 ± 0.2	3.5 ± 0.2	3.5 ± 0.2	25	50
B15 RH3.5x6x1.2	3.5 ± 0.2	3.5 ± 0.2	3.5 ± 0.2	30	55
B8 RH3.5x3x1.35	3.5 ± 0.2	3.5 ± 0.2	3.5 ± 0.2	15	35
B8 RH3.5x5x1.5	3.5 ± 0.2	3.5 ± 0.2	3.5 ± 0.2	18	35
B15 RH4x10x2	3.5 ± 0.2	3.5 ± 0.2	3.5 ± 0.2	30	55
B15 RH4.5x5x1.5	3.5 ± 0.2	3.5 ± 0.2	3.5 ± 0.2	30	60
B15 RH5x5x2.6	3.5 ± 0.2	3.5 ± 0.2	3.5 ± 0.2	26	55
B15 RH5x15x1.5	3.5 ± 0.2	3.5 ± 0.2	3.5 ± 0.2	80	140
B15 RH8x8x3.75	3.5 ± 0.2	3.5 ± 0.2	3.5 ± 0.2	30	70
B15 RH6x10x3	3.5 ± 0.2	3.5 ± 0.2	3.5 ± 0.2	48	80
B15 RH7.75x7.75x2.5	3.5 ± 0.2	3.5 ± 0.2	3.5 ± 0.2	56	92
B15 RH7.75x7.75x4	3.5 ± 0.2	3.5 ± 0.2	3.5 ± 0.2	35	65
B15 RH7.75x13x4	3.5 ± 0.2	3.5 ± 0.2	3.5 ± 0.2	56	90

RELIABILITY AND TEST CONDITIONS

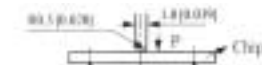
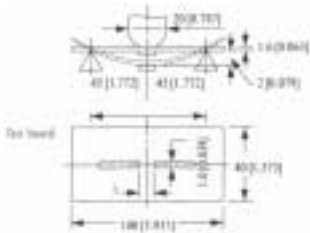
Operating Temperature Range	-25 to +85°C [-40 to +185°F]																						
Storage Temperature Range	-40 to +85°C [-40 to +185°F] 0 to 60°C [32 to 140°F] (In tape and reel packing)																						
Soldering Heat Resistance	The chip shall not crack. More than 75% of the terminal electrode shall be covered with solder.	Preheat: 120 to 150°C [248 to 302°F] for 60 seconds Solder: H63A (eutectic solder) Solder Temperature: 300 ± 5°C [572 ± 9°F] Flux: Rosin Dip time: 10 ± 0.5 seconds																					
Solderability	More than 90% of the terminal electrode shall be covered with new solder	Preheat: 120 to 150°C [248 to 302°F] for 60 seconds Solder: H63A (eutectic solder) Solder Temperature: 230 ± 5°C [572 ± 9°F] Flux: Rosin Dip Time: 3 ± 1 seconds																					
Terminal Strength	The terminal electrode shall not break off nor will the ferrite be damaged.	 <table border="1" style="margin-top: 10px; width: 100%;"> <thead> <tr> <th>Type</th> <th>W(N) [kgf]</th> <th>Time (sec.)</th> </tr> </thead> <tbody> <tr> <td>CB201209</td> <td>5.9[0.6]</td> <td rowspan="6" style="text-align: center; vertical-align: middle;">30 ± 5</td> </tr> <tr> <td>CB321611</td> <td>9.8[1.0]</td> </tr> <tr> <td>CB321616</td> <td>9.8[1.0]</td> </tr> <tr> <td>CB322513</td> <td>9.8[1.0]</td> </tr> <tr> <td>CB451616</td> <td>9.8[1.0]</td> </tr> <tr> <td>CB453215</td> <td>14.7[1.5]</td> </tr> </tbody> </table>	Type	W(N) [kgf]	Time (sec.)	CB201209	5.9[0.6]	30 ± 5	CB321611	9.8[1.0]	CB321616	9.8[1.0]	CB322513	9.8[1.0]	CB451616	9.8[1.0]	CB453215	14.7[1.5]					
Type	W(N) [kgf]	Time (sec.)																					
CB201209	5.9[0.6]	30 ± 5																					
CB321611	9.8[1.0]																						
CB321616	9.8[1.0]																						
CB322513	9.8[1.0]																						
CB451616	9.8[1.0]																						
CB453215	14.7[1.5]																						
Bending Strength	The ferrite shall not be damaged by forces applied on the right.	 <table border="1" style="margin-top: 10px; width: 100%;"> <thead> <tr> <th>Type</th> <th>A(mm) [inches]</th> <th>P(N) [kgf]</th> </tr> </thead> <tbody> <tr> <td>CB201209</td> <td>1.4[0.055]</td> <td>9.8[1.0]</td> </tr> <tr> <td>CB321611</td> <td>2.0[0.079]</td> <td>19.6[2.0]</td> </tr> <tr> <td>CB321616</td> <td>2.0[0.079]</td> <td>19.6[2.0]</td> </tr> <tr> <td>CB322513</td> <td>2.0[0.079]</td> <td>24.5[2.5]</td> </tr> <tr> <td>CB451616</td> <td>2.0[0.079]</td> <td>19.6[2.0]</td> </tr> <tr> <td>CB453215</td> <td>2.7[0.106]</td> <td>24.5[2.5]</td> </tr> </tbody> </table>	Type	A(mm) [inches]	P(N) [kgf]	CB201209	1.4[0.055]	9.8[1.0]	CB321611	2.0[0.079]	19.6[2.0]	CB321616	2.0[0.079]	19.6[2.0]	CB322513	2.0[0.079]	24.5[2.5]	CB451616	2.0[0.079]	19.6[2.0]	CB453215	2.7[0.106]	24.5[2.5]
Type	A(mm) [inches]	P(N) [kgf]																					
CB201209	1.4[0.055]	9.8[1.0]																					
CB321611	2.0[0.079]	19.6[2.0]																					
CB321616	2.0[0.079]	19.6[2.0]																					
CB322513	2.0[0.079]	24.5[2.5]																					
CB451616	2.0[0.079]	19.6[2.0]																					
CB453215	2.7[0.106]	24.5[2.5]																					
Flexure Strength	No mechanical damage shall be noticed even when the board is bent 2mm [0.079 inches].																						
Thermal Shock (Temperature Cycle)	Impedance shall be within ± 20% of the initial value.	Temperature: -25°C [-13°F], +85°C [+185°F] for 30 minutes each, 50 cycles.																					
High Temperature Resistance		Applied 200mA DC and placed at 80°C [176°F] for 500 hours, then measured at room ambient temperature.																					
Humidity Resistance		Applied 200mA DC and placed at 90%RH, 60°C [140°F] for 500 hours, then measured at room ambient temperature.																					
Drop		Drop 10 times on a concrete floor from a height of 1m [39.370 inches]																					
Vibration		Frequency: 10 to 55Hz Amplitude: 1.52mm [0.060 inches] Direction and time: X, Y and Z direction for 2 hours each.																					
Solvent Resistance		Solvent: Trichloroethylene Washer: Ultrasonic washer (100W) Washing time: 3 minutes																					

Packing

Available in Bulk, or Tape and Reels

Tape Dimensions

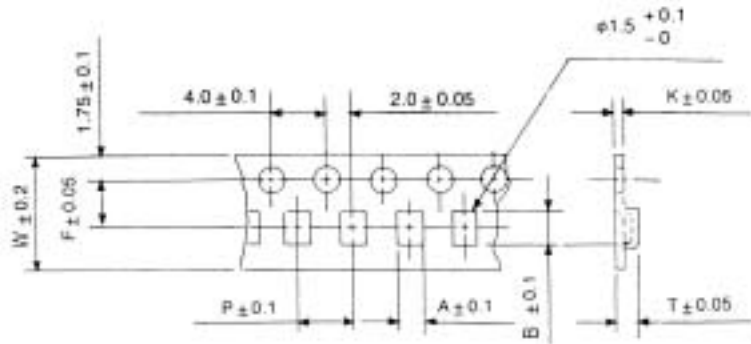

Type	CB160808	CB201209	CB321611	CB321616	CB322513	CB451616	CB453215	CB575018	CB575032
A	1.5	1.5	1.9	1.9	2.9	1.9	3.6	5.6	5.6
B	2.3	2.3	3.5	3.5	3.6	4.9	4.9	6.4	6.4
W	8.0	8.0	8.0	8.0	8.0	12.0	12.0	14.0	14.0
T	4.0	4.0	4.0	4.0	4.0	4.0	8.0	8.0	8.0
H	1.3	1.3	1.5	2.0	1.7	2.0	1.9	2.55	3.95
Chips/Reel	4000	4000	2000	2000	2000	2000	1000	500	500

Tape Material

Carrier Tape: Polystyrene

Cover Tape: Polystyrene

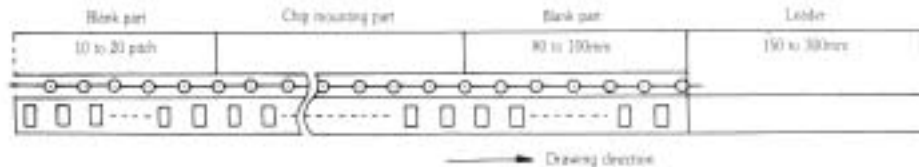

Reel Dimensions

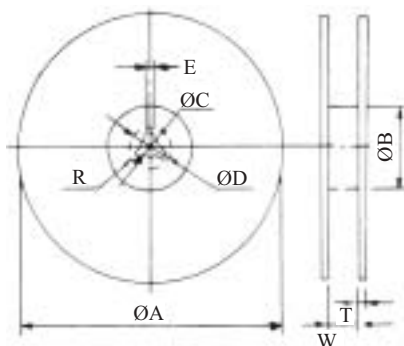

Type	160808	201209	321611	321616	322513	451616	453215	575018	575032
A			178 ± 2					178 ± 2	
B			60 ± 1					60 ± 1	
C			13.0 ± 0.5					13.0 ± 0.5	
D			21.0 ± 0.8					21.0 ± 0.8	
E			2.0 ± 0.5					2.0 ± 0.5	
W			10.0 ± 1.0					10.0 ± 1.0	
T			2.0 ± 0.5					2.0 ± 0.5	
R			1.0					1.0	

- Typical | Z |, R, X_L Frequency Characteristics

CB 201209T-151Y-C2

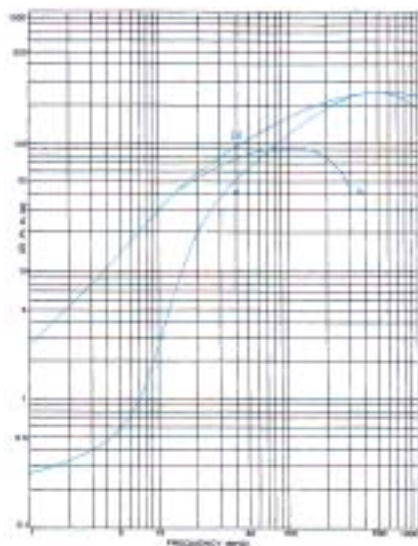

CB 201209T-601Y-C2

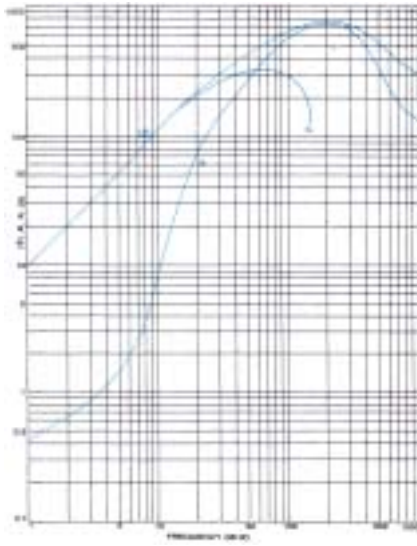

CB 321611T-320Y-C3

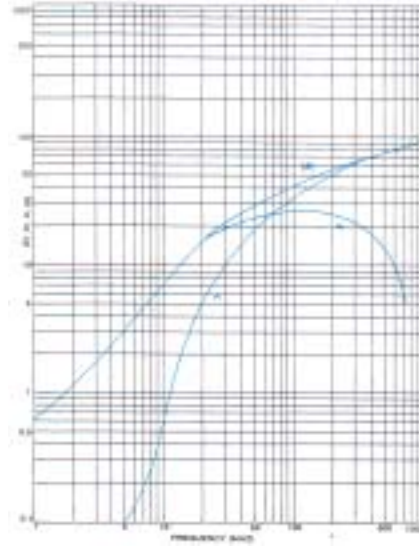

CB 321611T-601Y-C2

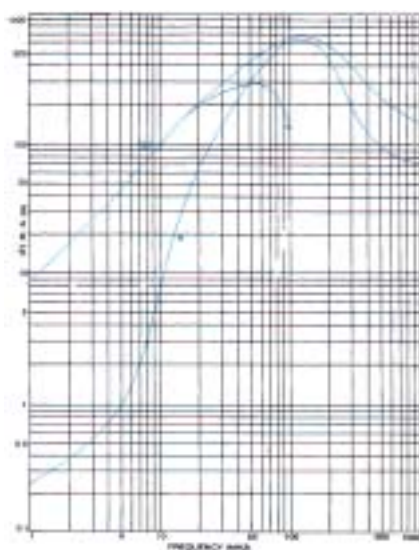

CB 322513T-900Y-C3

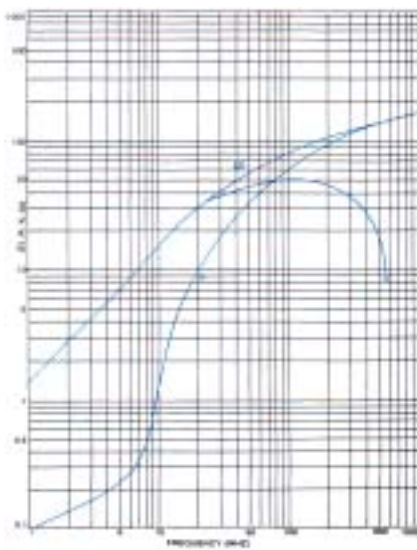

CB 453215T-121Y-C3

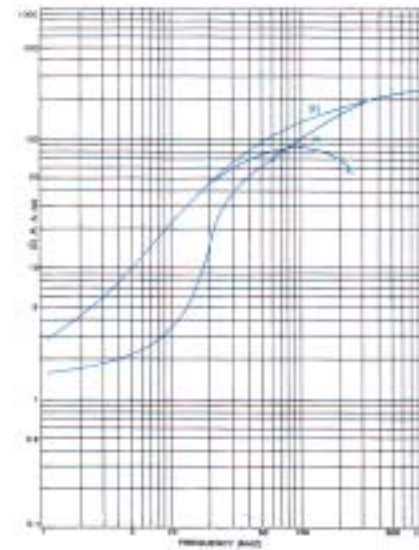

4. Electrical characteristics:

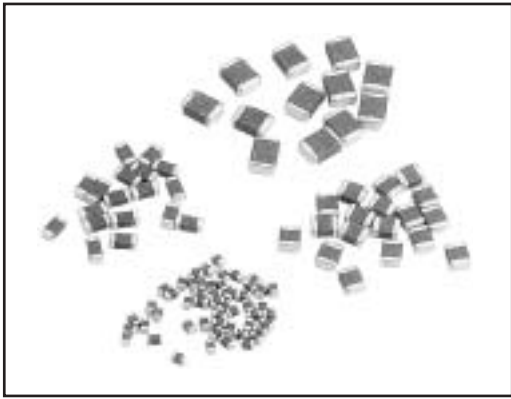

1. Shape:

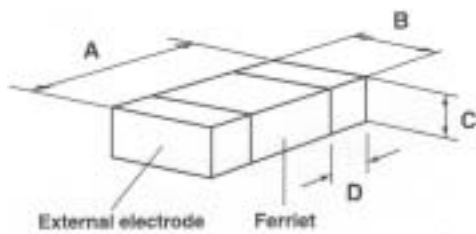

2. Ordering Code:

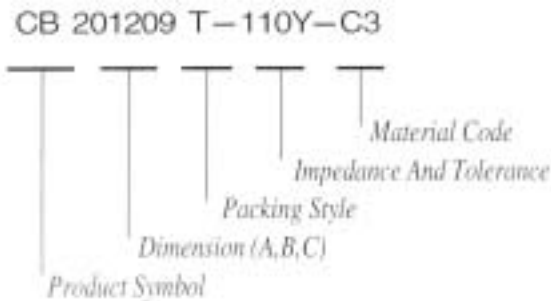

3. Dimensions in mm (inches):

Part No.	Impedance (Ω) At 100 MHz	DC Resistance (Ω) Max	Rated Current (mA) Max
CB160808T-400Y-C3	40 \pm 25%	0.30	400
CB160808T-800Y-C3	80 \pm 25%	0.50	300
CB160808T-121Y-C3	120 \pm 25%	.070	200
CB160808T-301Y-C3	300 \pm 25%	1.20	150
CB201209T-110Y-C3	11 \pm 25%	0.10	600
CB201209T-320Y-C3	32 \pm 25%	0.30	500
CB201209T-121Y-C3	120 \pm 25%	0.50	300
CB201209T-181Y-C3	180 \pm 25%	0.70	200
CB201209T-301Y-C3	300 \pm 25%	0.80	200
CB201209T-601Y-C3	600 \pm 25%	0.90	200
CB201209T-102Y-C3	1000 \pm 25%	1.00	100
CB321611T-320Y-C3	32 \pm 25%	0.15	500
CB321611T-900Y-C3	90 \pm 25%	0.30	400
CB321611T-151Y-C3	150 \pm 25%	0.40	200
CB321611T-301Y-C3	300 \pm 25%	0.50	200
CB321611T-601Y-C3	600 \pm 25%	0.50	200
CB321611T-102Y-C3	1000 \pm 25%	1.00	100
CB321616T-600Y-C3	60 \pm 25%	0.50	200
CB322513T-320Y-C3	32 \pm 25%	0.30	400
CB322513T-600Y-C3	60 \pm 25%	0.30	400
CB322513T-900Y-C3	90 \pm 25%	0.30	400
CB451616T-600Y-C3	60 \pm 25%	0.30	400
CB451616T-151Y-C3	150 \pm 25%	0.50	200
CB453215T-700Y-C3	70 \pm 25%	0.40	300
CB453215T-121Y-C3	120 \pm 25%	0.40	300
CB575018T-101Y-C3	100 \pm 25%	0.04	3000
CB575032T-301Y-C3	300 \pm 25%	0.04	3000
CB575032T-401Y-C3	400 \pm 25%	0.04	3000

Part No.	A	B	C	D
CB 160808	1.6 \pm 0.20 (0.063 \pm 0.008)	0.9 \pm 0.20 (0.035 \pm 0.008)	0.9 \pm 0.20 (0.035 \pm 0.008)	0.3 \pm 0.20 (0.012 \pm 0.008)
CB 201209	2.0 \pm 0.20 (0.079 \pm 0.008)	1.25 \pm 0.20 (0.047 \pm 0.008)	0.9 \pm 0.20 (0.035 \pm 0.008)	0.5 \pm 0.30 (0.020 \pm 0.012)
CB 321611	3.2 \pm 0.20 (0.126 \pm 0.008)	1.6 \pm 0.20 (0.063 \pm 0.008)	1.1 \pm 0.20 (0.043 \pm 0.008)	0.5 \pm 0.30 (0.020 \pm 0.012)
CB 321616	3.2 \pm 0.20 (0.126 \pm 0.008)	1.6 \pm 0.20 (0.063 \pm 0.008)	1.6 \pm 0.20 (0.063 \pm 0.008)	0.5 \pm 0.30 (0.020 \pm 0.012)
CB 322513	3.2 \pm 0.20 (0.126 \pm 0.008)	2.50 \pm 0.20 (0.098 \pm 0.008)	1.3 \pm 0.20 (0.051 \pm 0.008)	0.5 \pm 0.30 (0.020 \pm 0.012)
CB 451616	4.5 \pm 0.25 (0.177 \pm 0.008)	1.60 \pm 0.20 (0.063 \pm 0.008)	1.60 \pm 0.20 (0.063 \pm 0.008)	0.5 \pm 0.30 (0.020 \pm 0.012)
CB 453215	4.5 \pm 0.25 (0.177 \pm 0.008)	3.20 \pm 0.20 (0.126 \pm 0.008)	1.5 \pm 0.20 (0.059 \pm 0.008)	0.5 \pm 0.30 (0.020 \pm 0.012)
CB 575018	5.7 \pm 0.40 (0.225 \pm 0.016)	5.00 \pm 0.30 (0.197 \pm 0.012)	1.80 \pm 0.30 (0.071 \pm 0.012)	0.5 \pm 0.30 (0.020 \pm 0.012)
CB 575032	5.7 \pm 0.40 (0.225 \pm 0.016)	5.00 \pm 0.30 (0.197 \pm 0.012)	3.20 \pm 0.30 (0.126 \pm 0.012)	0.5 \pm 0.30 (0.020 \pm 0.012)

1. Ordering Code:

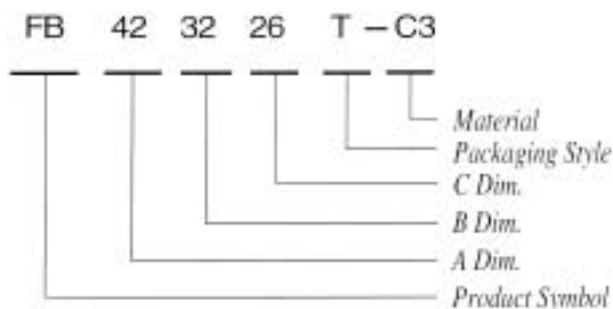

2. Shape:

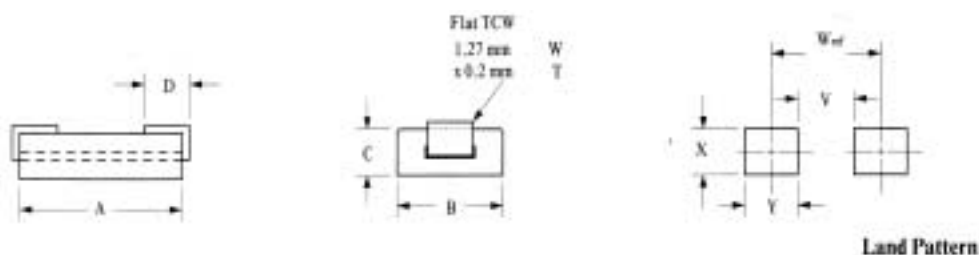

3. Dimensions: (m/m)

Part Number	A	B	C	D	V	Wref	X	Y
FB423226	4.0 ± 0.25	3.0 ± 0.15	2.55 ± 0.15	1.5 ± 0.5	1.9	4.9	3.0	3.0
FB863226	8.5 ± 0.3	3.0 ± 0.15	2.55 ± 0.15	1.5 ± 0.5	6.4	9.4	3.0	3.0
FB784729	7.8 ± 0.4	4.75 ± 0.25	2.92 ± 0.25	1.50.5	5.5	8.7	3.0	3.0

4. Electrical Characteristics:

Part Number	Impedance (Ω) Min.		Rdc (Ω) Max.
	25MHz	100MHz	
FB423226-C3	20	35	0.6
FB863226-C3	45	80	0.9
FB784729-C3	45	80	0.9

TEST INSTRUMENTS:
HP419A RF IMPEDANCE ANALYZER

5. Packaging: 500 pcs. per Reel

Material	Ui	Working Frequency (MHz)	Tan δ / ui X10 ⁻⁵	Bms Gauss	Br Gauss	HC Oe	TC °C	ρ (Ω -cm)
A	550	0.1~2	2.3 (0.2 MHz)	2700	800	0.28	150	10 ⁷
A1	200	0.4~2	5.0 (0.2 MHz)	2600	600	0.14	150	10 ⁷
A2G	300	0.4~2	2.0 (0.4 MHz)	2700	1600	0.52	150	10 ⁷
A3	250	0.1~6	18.0 (1 MHz)	3000	1500	0.75	200	10 ⁷
A5	100	0.5~20	5.0 (2 MHz)	3000	1800	2.0	330	10 ⁴
B7	750	0.1~0.7	7.0 (0.3 MHz)	2900	600	0.3	130	10 ⁷
B8	800	0.1~0.7	6.9 (0.5 MHz)	2400	850	0.3	140	10 ⁷
B10	1000	0.01~0.5	2.0 (0.1 MHz)	2900	900	0.35	100	10 ⁷
B12	1200	0.01~0.5	2.1 (0.1 MHz)	2900	900	0.3	100	10 ⁷
B15	1500	0.01~0.5	6.0 (0.1MHz)	2800	600	0.2	100	10 ⁷
B18	1800	0.01~0.5	2.5 (0.1 MHz)	2900	700	0.16	100	10 ⁷
B30	3000	0.01~0.5	2.0 (0.1 MHz)	2800	650	0.08	100	10 ⁷
K1	55	0.5~15	10.0 (2 MHz)	2800	1150	3.6	300	10 ⁷
K2	70	0.5~15	10.0 (2 MHz)	2900	2200	3.48	300	10 ⁷
K3	10	10~150	40.0 (10 MHz)	1400	500	16.9	300	10 ⁷
DB3	300	0.1~2	4.0 (0.4 MHz)	2900	1500	0.56	180	10 ⁷
N9D	50	0.5~50	18 (2 MHz)	3100	2250	6.6	300	10 ⁷
C2	200	0.1~2	5.3 (1 MHz)	2400	630	1.9	175	10 ⁷
C3	300	0.1~1	3.2 (1 MHz)	2800	1440	0.8	175	10 ⁷

Page 3



EMI SURFACE MOUNT BEADS / FB TYPE

Page 20



FLAT CABLE EMI CORES / FP FI TYPE

Page 26



MULTI-APERTURE CORES / RID TYPE

Page 4



EMI MULTILAYER FERRITE CHIP BEADS / CB TYPE

Page 22



ROUND CABLE EMI CORES / FH TYPE

Page 27



ANTENNA FERRITE BAR / AP AR TYPE

Page 12



EMI BEAD CORES / RH TYPE

Page 24



CONNECTOR EMI CORES / FD FDH TYPE

Page 31



Mn-Zn TOROID CORES

Page 16



EMI TOROID CORES / T TYPE

Page 25



MULTI-APERTURE WOUND BEADS / R6H TYPE

Page 33



IRON POWDER CORES

4. Shape:

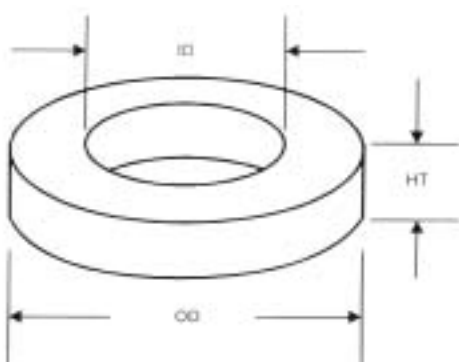

5. Dimensions and Magnetic Parameters

PART NO.	OD m/m	HT m/m	ID m/m	AL nH/N ²	L cm	A cm ²
T37-26	9.53 ± 0.4	3.25 ± 0.4	5.2 ± 0.4	26 ⁻⁰	2.31	0.64
T44-36	11.2 ± 0.4	4.04 ± 0.4	5.82 ± 0.4	34 ⁻⁰	2.68	0.99
T50-26	12.7 ± 0.4	4.83 ± 0.4	7.7 ± 0.4	31 ⁻⁰	3.20	0.12
T50-26B	12.7 ± 0.4	6.35 ± 0.4	7.7 ± 0.4	41 ⁻⁰	3.20	0.15
T50-26D	12.7 ± 0.4	9.35 ± 0.4	7.7 ± 0.4	67 ⁻⁰	3.20	0.22
T60-26	15.2 ± 0.4	5.94 ± 0.4	8.53 ± 0.4	47 ⁻⁰	3.74	0.19
T68-26	17.5 ± 0.4	4.83 ± 0.4	9.4 ± 0.4	41 ⁻⁰	4.24	0.19
T68-26A	17.5 ± 0.4	6.35 ± 0.4	9.4 ± 0.4	54 ⁻⁰	4.24	0.24
T80-26	20.2 ± 0.4	6.35 ± 0.4	12.6 ± 0.4	43 ⁻⁰	5.15	0.24
T80-26B	20.2 ± 0.4	9.53 ± 0.4	12.6 ± 0.4	66 ⁻⁰	5.15	0.35
T90-26	22.9 ± 0.5	9.53 ± 0.5	1.40 ± 0.5	65 ⁻⁰	5.80	0.42
T106-26	26.9 ± 0.5	11.1 ± 0.5	14.5 ± 0.5	87 ⁻⁰	6.50	0.69
T130-26	33.0 ± 0.5	11.1 ± 0.5	19.8 ± 0.5	76 ⁻⁰	8.29	0.73
T130-26A	33.0 ± 0.5	5.72 ± 0.5	19.8 ± 0.5	40 ⁻⁰	8.29	0.36